

Article number: 54810052093

Description: 4 hole Flange Unit SSUCF209 for shaft $\varnothing 45\text{mm}$
Massive stainless steel, polished

Measures

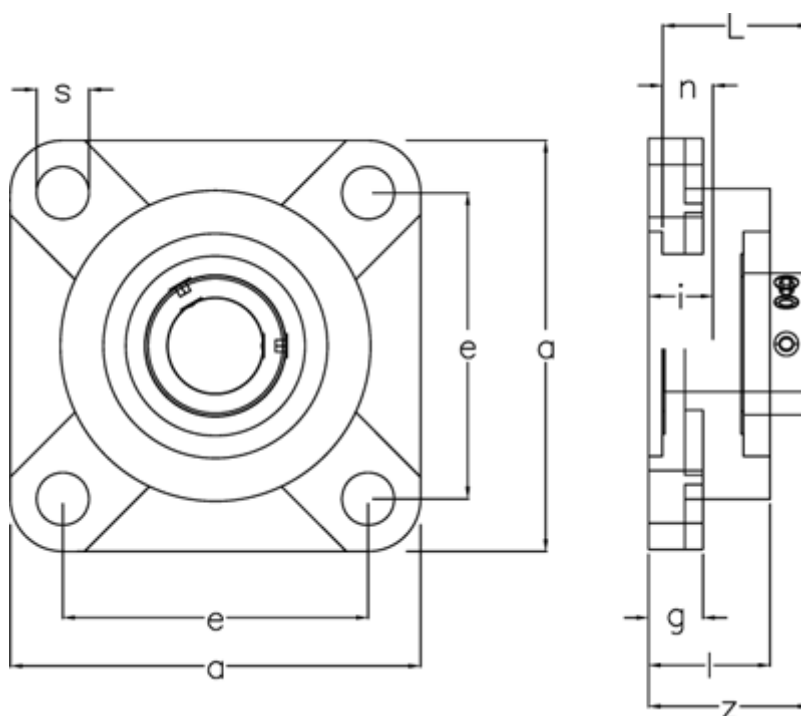

a	= 137	L	= 49.2
Bearing	= SUC209	Nominal drive	= 19.0
Bolt size	= M14	s	= 16
e	= 105	Weight	= 2.58
g	= 16.0	z	= 52.2
Housing	= SF209		
i	= 22		
l	= 38.0		